

Friggebod Barbados 44

Art.Nr. 4417340

1/8

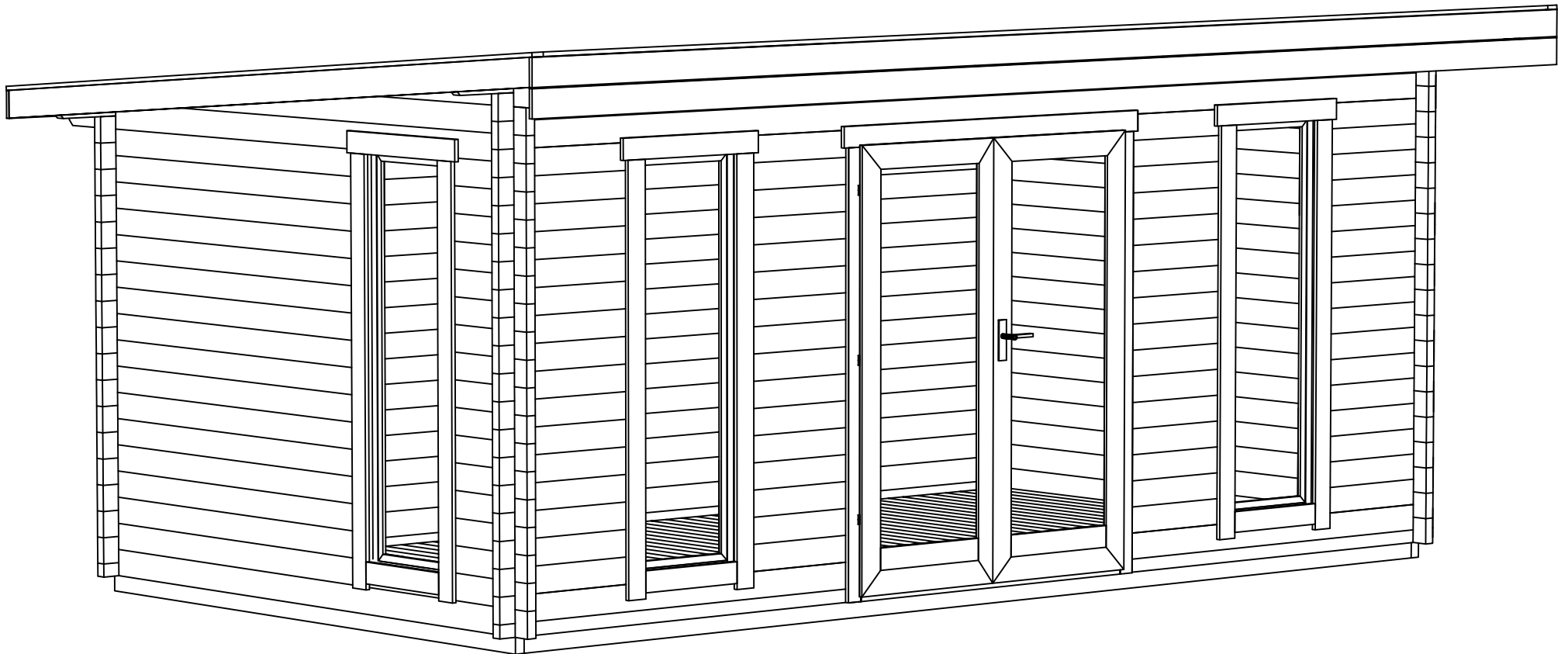

2.02.2015

GROUNDPLAN - GRUNDPLAN - PLAN DE MASSE

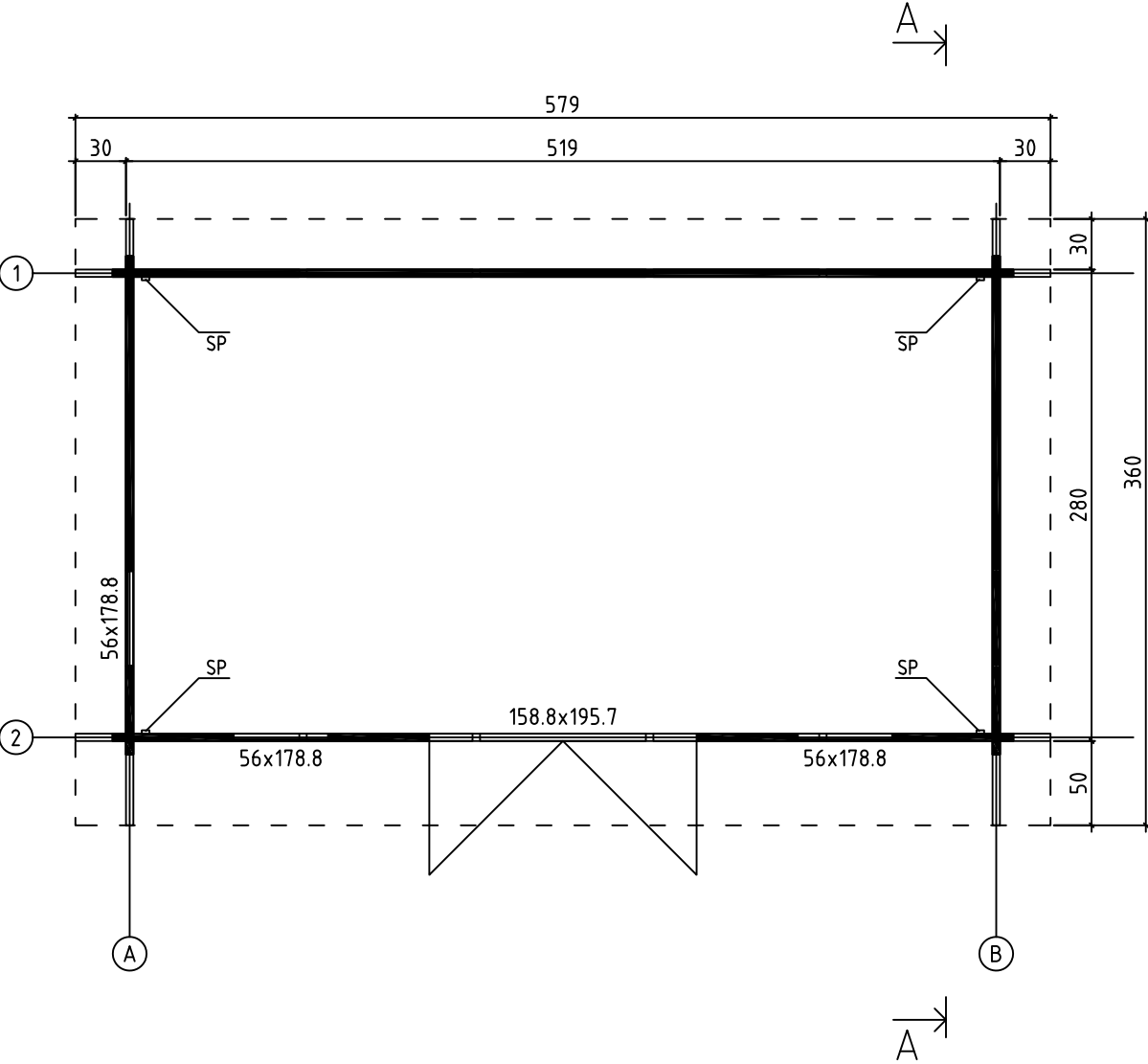

FOUNDATION - FUNDAMENT - FONDATION

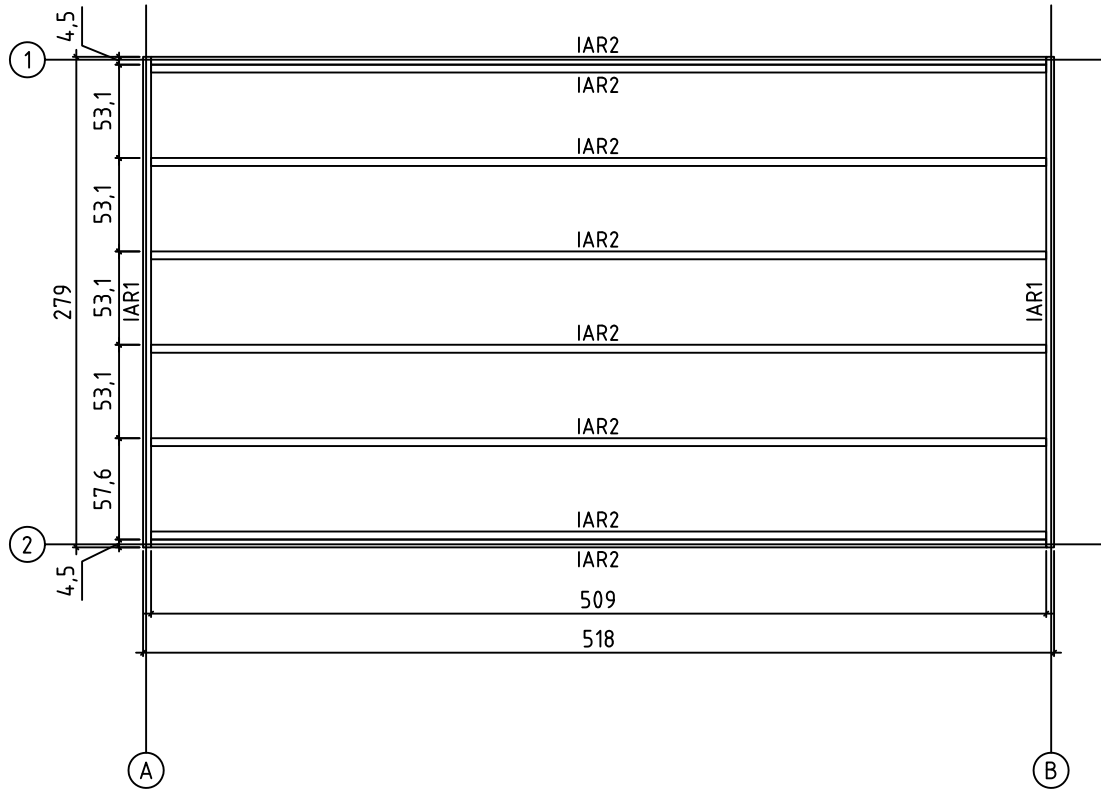

FLOOR BOARDS - FUSSBODENBRETTER - PLAN POSE PLANCHER

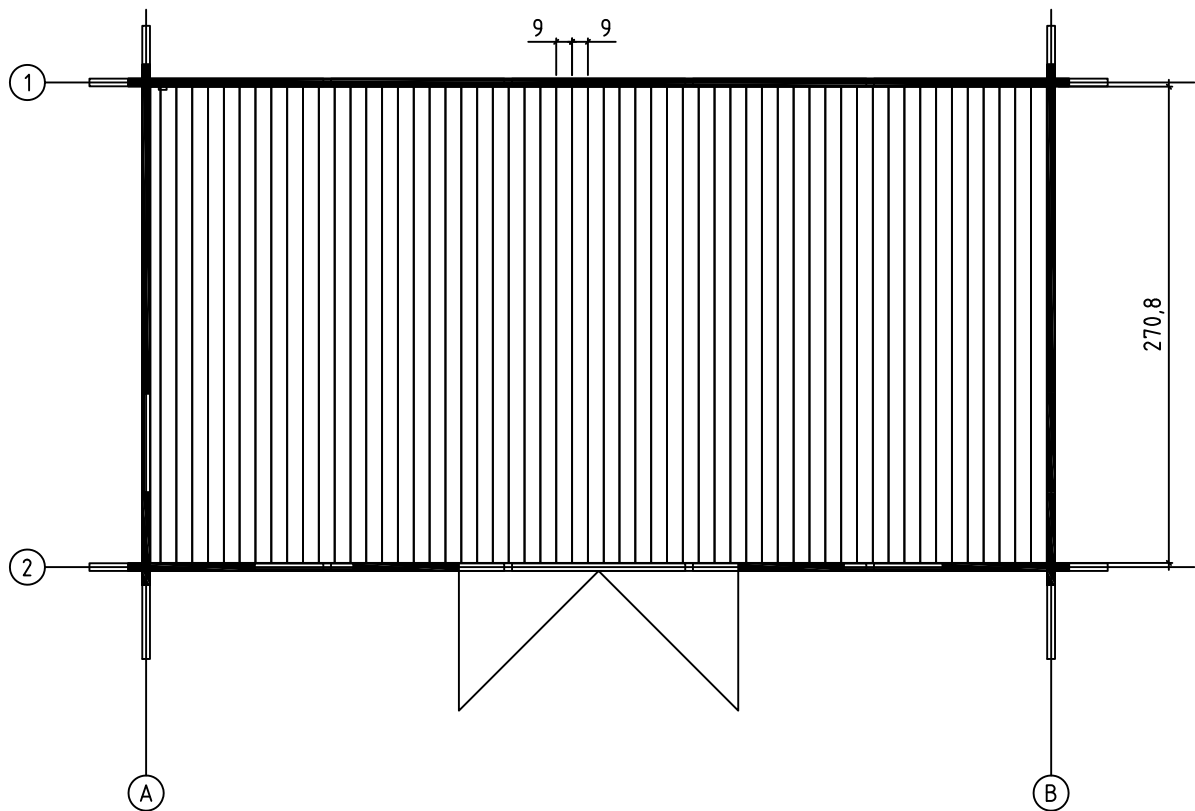

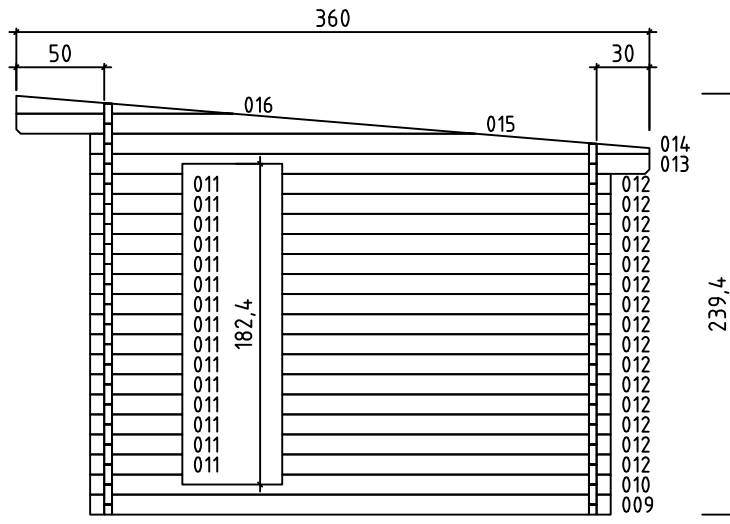

Wall - Wand - Mur A ↗

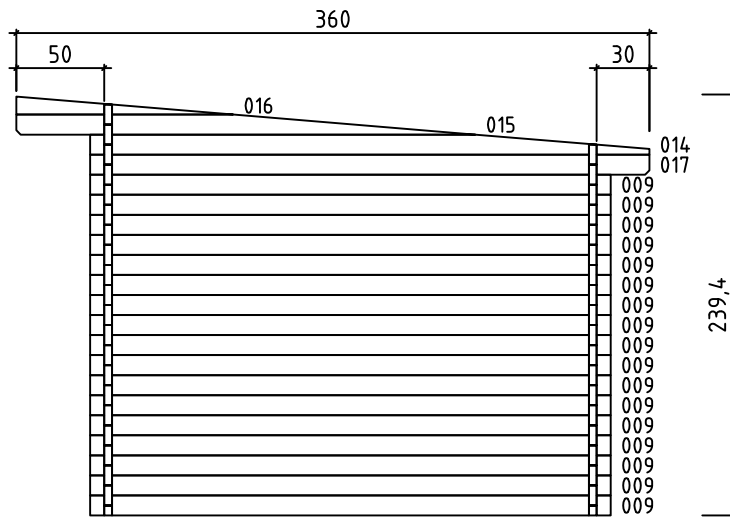
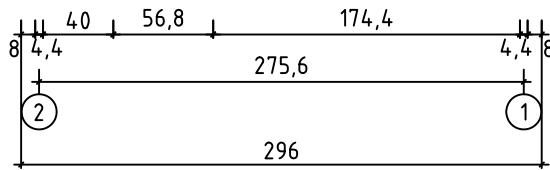

Wall - Wand - Mur B ↗

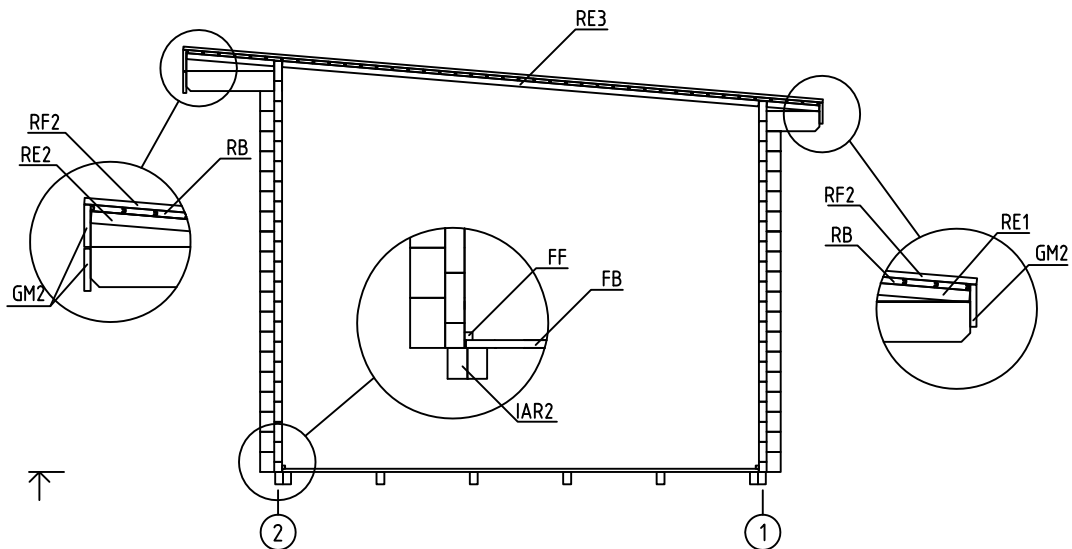
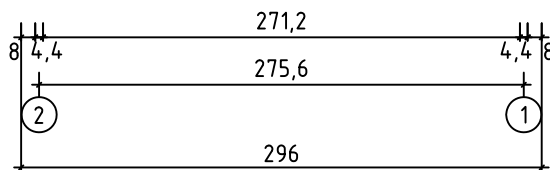



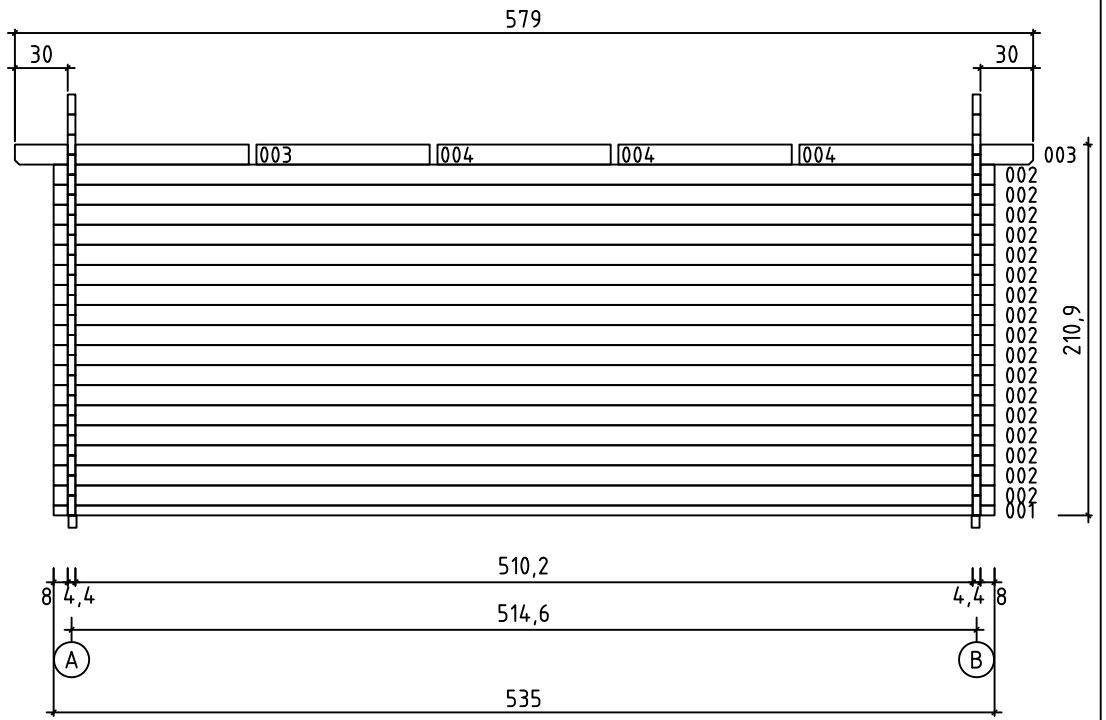



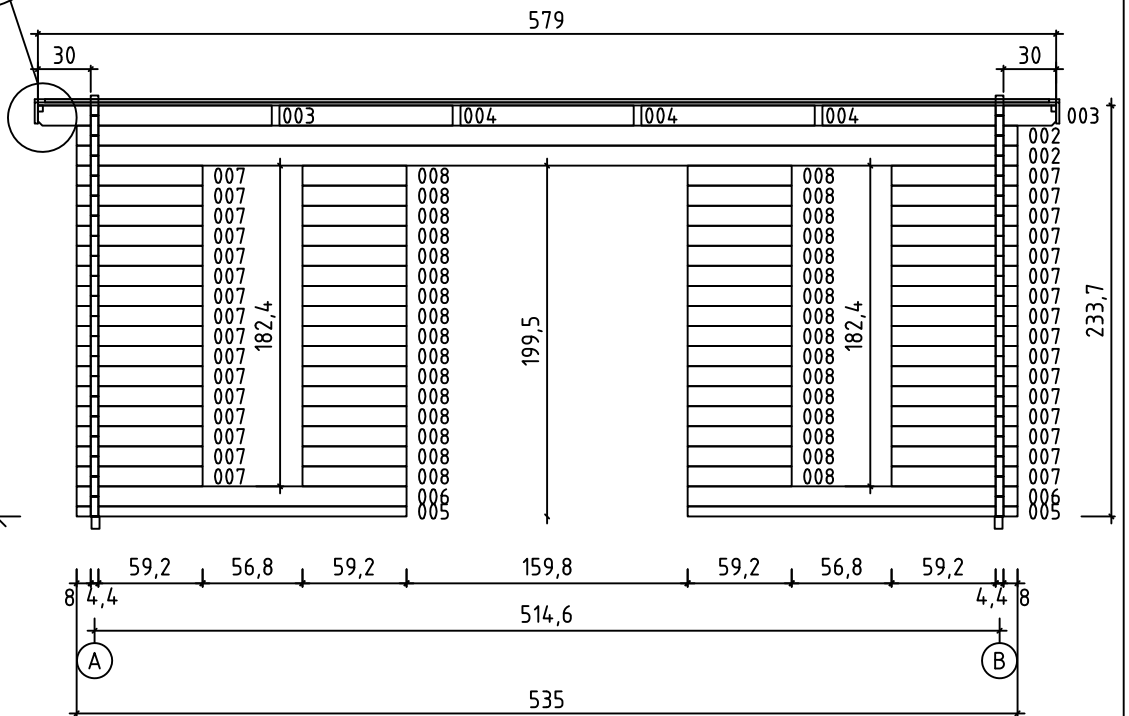
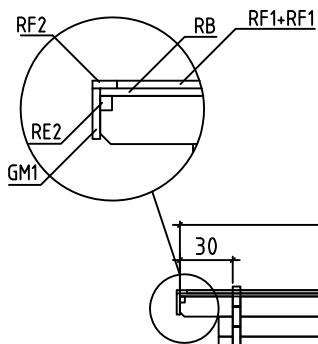



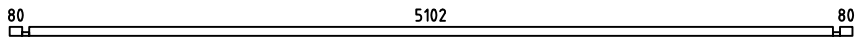
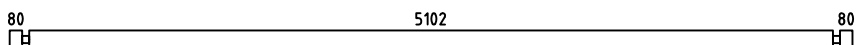
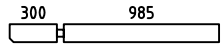
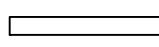
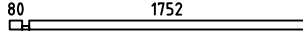
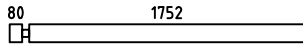
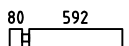

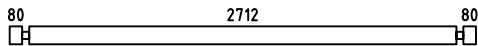
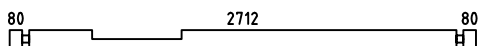
A-A ↗

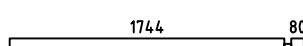
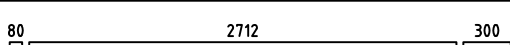
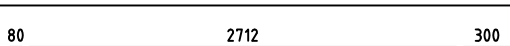
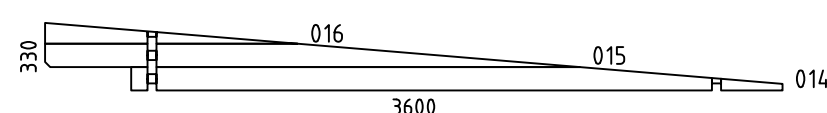
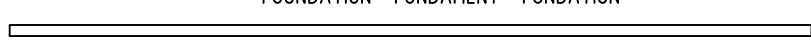
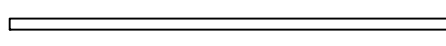



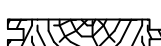









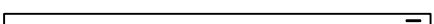
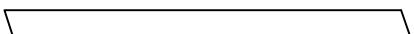
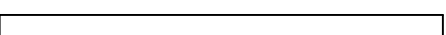

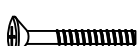

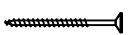





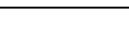

Wall - Wand - Mur 1 ↗

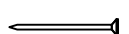

Wall - Wand - Mur 2 ↗

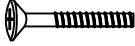
Pos	2.02.2015	Piece list - Stückliste - Liste des pièces Art.Nr. 4417340	6/8	Q.	P (mm)	L (mm)
001				1	44x57	5350
002				19	44x114	5350
003				4	44x114	1329
004				6	44x114	985
005				2	44x57	1876
006				2	44x114	1876
007				32	44x114	716
008				32	44x114	592
009				18	44x114	2960
010				1	44x114	2960
011				15	44x114	524
012				15	44x114	1868
013				1	44x114	3180
017				1	44x114	3180
WA-1 WB-1				1 1		
IAR2		FOUNDATION - FUNDAMENT - FONDATION 		8	45x70	5090
IAR1		FOUNDATION - FUNDAMENT - FONDATION 		2	45x70	2790
SR1		RAFTER - DACHSPARREN - CHEVRON 4,7° 		4	44x140	3624
FB		FLOOR BOARDS - FUSSBODENBRETTER - LAME DE PLANCHER 		57	90x18	2708
RB1		ROOF BOARDS - DACHBRETTER - VOLIGES 		41	90x18	4439
RB2		ROOF BOARDS - DACHBRETTER - VOLIGES 		41	90x18	1351
FF		FLOOR FILLET - FUSSBODENLEISTE - CORNIERE DE FINITION DU PLANCHER 			18x18	15.61
RF1		ROOFING FELT FILLET - DACHPAPPENLEISTE - BAGUETTE DE FIXATION DU FEUTRE BITUMEUX 		2	18x58	2855
RF2		ROOFING FELT FILLET - DACHPAPPENLEISTE - BAGUETTE DE FIXATION DU FEUTRE BITUMEUX 		2	18x58	3649

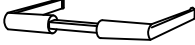
Pos	2.02.2015	Piece list – Stückliste – Liste des pièces Art.Nr. 4417340	7/8	Q.	P (mm)	L (mm)
RE1		ROOF EDGE REINFORCEMENT – DACHRANDVERSTÄRKUNG – CORNIERE DE RENFORT DE BORD DE TOIT		2	28x34	297
RE2		ROOF EDGE REINFORCEMENT – DACHRANDVERSTÄRKUNG – CORNIERE DE RENFORT DE BORD DE TOIT		2	28x34	500
RE3		ROOF EDGE REINFORCEMENT – DACHRANDVERSTÄRKUNG – CORNIERE DE RENFORT DE BORD DE TOIT		2	28x34	2718
SP		STORM PROTECTION – STURMLEISTE – LATTE ANTI-TEMPETE		2	22x45	2020
SP		STORM PROTECTION – STURMLEISTE – LATTE ANTI-TEMPETE		2	22x45	2250
GM1		GABLE MOULDING – GIEBELLEISTE – PLANCHE DE RIVE		2	18x120	3622
GM2		GABLE MOULDING – GIEBELLEISTE – PLANCHE DE RIVE		3	18x120	5826
FS		WINDOW HANDLE FITTINGS – FENSTERGRIFF – POIGNEE DE FENETRE		6		
		BOLT FOR WINDOW HANDLE FITTINGS – BOLZEN FÜR FENSTERGRIFF BESCHLAG – VIS POUR FIXATION POIGNEE DE FENETRE		12		
HS16		SCREW FOR GABLE MOULDING – SCHRAUBEN FÜR GIEBELLEISTE – VIS POUR FIXATION PLANCHE DE RIVE		66	3.5x50	
HS3		SCREW FOR DOOR FILLET – SCHRAUBE ZUR BEFESTIGUNG TÜRLEISTE – VIS POUR FIXATION BAGUETTE D'ARRET DE PORTE		5	3x30	
		SCREW FOR ROOF EDGE REINFORCEMENT – SCHRAUBEN FÜR DACHRANDVERSTÄRKUNG – VIS POUR FIXATION CORNIERE RENFORT DE BORD DE TOIT		20	4x40	
HS43		SCREW FOR ROOF BEAMS – SCHRAUBEN FÜR DACHBALKEN – VIS POUR FIXATION PANNES DE TOIT		12	5x120	
		SCREW FOR GABLE – SCHRAUBEN FÜR GIEBEL – VIS POUR FIXATION DES PIGNONS		8	5x120	
		SCREW FOR 1. WALL BEAM – SCHRAUBE FÜR 1. BOHLENREIHE – VIS DE FIXATIONS 1ERE RANGÉE DE MADRIERS AVEC POUTRELLES DE FONDATIONS		8	5x90	
		SCREW FOR FOUNDATION – SCHRAUBEN ZUR BEFESTIGUNG FUNDAMENT – VIS DE FIXATIONS DES POUTRELLES DE FONDATIONS		24	5x90	
HS41		SCREW FOR DOOR JAMB – SCHRAUBE FÜR TÜRRAHMEN – VIS POUR FIXATION MONTANT DE PORTE		4	5x90	
		SCREW FOR Pos. 003, 004 – SCHRAUBEN FÜR für Pos. 003, 004 VIS POUR FIXATION DERNIÈRE RANGÉE MADRIERS (MURS AVANT ET ARRIÈRE)		10	6x180	
HS59		SCREW FOR DOORSTEP – SCHRAUBEN FÜR SWELLE – VIS POUR FIXATION BARRE DE SEUIL		3	4.5x65	
		ZN NAIL FOR FLOOR FILLET – ZN NÄGEL FÜR FUSSBODENLEISTE – POINTE POUR CORNIERE DE FINITION DU PLANCHER		32	1.4x40	
SH44		HAMMER BLOCK – SCHLAGHOLZ – CALLE DE FRAPPE		1		
SFS		NUT FOR STORM PROTECTION – SCHRAUBENMUTTER FÜR STURMLEISTE – ECROU POUR LATTE ANTI-TEMPETE		8		
NF2		ZN NAIL FOR ROOF – ZN NÄGEL FÜR DACHBRETTER – POINTE POUR FIXATION VOLIGES DE TOIT		308	2x50	
		ZN NAIL FOR FLOOR – ZN NÄGEL FÜR FUSSBODENBRETTER – CLOUS POUR PLANCHER		348	2x50	
NFD		ZN NAIL FOR ROOFING FELT FILLET – ZN NÄGEL FÜR DACHPAPPENLEISTE – POINTE POUR BAGUETTE DE FIXATION FEUTRE BITUMEUX		30	2x40	

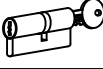
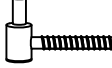
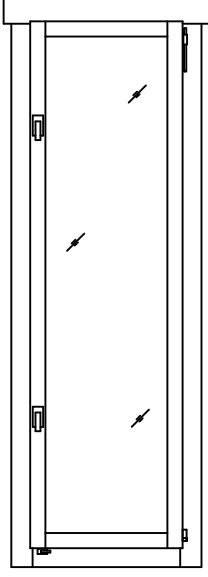
Pos	2.02.2015	Piece list - Stückliste - Liste des pièces Art.Nr. 4417340	8/8	Q.	P (mm)	L (mm)
BFS	BOLT FOR STORM PROTECTION - BOLZEN FÜR STURMLEISTE - BOULON POUR LATTE ANTI-TEMPETE			8		
DFS	WASHER FOR STORM PROTECTION - DICHTSCHEIBE FÜR STURMLEISTE - RONDELLE POUR LATTE ANTI-TEMPETE			8		
TL4	DOOR HANDLE FITTINGS - TÜRGRIF - POIGNEE DE PORTE			1		
TL5	SET OF DOOR LOCK COVERS - SCHLOSSBLENDEN - SET DE GARNITURES DE PORTE			1		
	CYLINDER LOCK - ZYLINDERSCHLOSS - BARILLET DE PORTE			1		
	MALE BOLT HINGE FOR DOOR - TÜRRIEGEL - PARTIE MALE DE PAUMELLE DE PORTE			6		
	WINDOW-FENSTER-FENETRE 560x1788	AK.1.100.PSP	DGP	3		
						
	DOOR-TÜR-PORTE 1588x1957	TUK.1.100.PVP.MM	DGP	1		
